

Owner's Manual & Safety Instructions

Save This Manual Keep this manual for the safety warnings and precautions, assembly, operating, inspection, maintenance and cleaning procedures. Write the product's serial number in the back of the manual near the assembly diagram (or month and year of purchase if product has no number). Keep this manual and the receipt in a safe and dry place for future reference.

21e

BADLAND® APEX™

LONG DRUM UTV WINCH 5500LB.



Visit our website at: <http://www.harborfreight.com>
Email our technical support at: productsupport@harborfreight.com

57535

When unpacking, make sure that the product is intact and undamaged. If any parts are missing or broken, please call 1-888-866-5797 as soon as possible.





Copyright© 2020 by Harbor Freight Tools®. All rights reserved.
No portion of this manual or any artwork contained herein may be reproduced in any shape or form without the express written consent of Harbor Freight Tools. Diagrams within this manual may not be drawn proportionally. Due to continuing improvements, actual product may differ slightly from the product described herein. Tools required for assembly and service may not be included.

⚠WARNING

Read this material before using this product. Failure to do so can result in serious injury. **SAVE THIS MANUAL.**

Specifications











Rated Single Line Pull	5500 lb (2494 kg)	Battery	12VDC, Minimum 12 Ah
Application	ATV/UTV	Battery Cables	6 gauge, 3' (0.9m) long
Motor	12VDC 1.5 HP Permanent Magnet	Solenoid Cables	6 gauge, 8' (2.4m) long
Power IN & Power OUT	Yes	Mounting Pattern	3" x 6.6" (76.2mm x 167.8mm)
Duty Cycle Rating	5% (45 sec at Max Rated Load; 14 min, 15 sec Rest)	Mounting Hardware	Winch: 4x G8, M8-1.25 x 25 mm Adaptor Plate: 2x G8, M8-1.25 x 25 mm Fairlead: 2x G8, M8-1.25 x 20 mm Socket Lead: 2x G8, ST-M4 x 30 mm
Remote Control	Wired, 10 ft (3m) long	Sound Rating	85 dB
Dash Rocker Switch	Wired, 4 ft (1.2m) long	Overall Dimensions (L x D x H)	15.87" x 4.72" x 5.0" (403 x 120 x 127 mm)
Geartrain	3-Stage Planetary	Weight	20.78 lb (9.4 kg)
Gear Ratio	201:1	IP Rating	IP 68 – Winch and Controls (except remote switch, resistant to powerful water jets)
Freespool	Cam Activated		
Brake	Auto. Load Holding Mechanical		
Drum (Dia. x L)	2.36" x 5.16" (60mm x 131 mm)		
Hook	5/16" Clevis, with Spring-loaded Safety Latch		
Fairlead	Aluminum Hawse		
Synthetic Rope Size / Type	Ø1/4" x 50' (Ø6.3mm x 15.2m)		



Layer	Rated Line Pull	Synthetic Rope Capacity
 1	5500 lb (2494 kg)	12.9' (3.94m)
 2	4654 lb (2111 kg)	28.2' (8.59m)
 3	4033 lb (1829 kg)	45.8' (13.97m)
 4	3559 lb (1614 kg)	50.0' (15.24m)

First Layer of Synthetic Rope Performance					
 1	Line Pull lb (kg)		Line Speed fpm (mpm)		Amp Draw (@ 12V)
	0 (0)		18.7 (5.7)		31
	500 (227)		16.3 (4.9)		51
	1500 (680)		15.0 (4.5)		88
	2500 (1134)		13.5 (4.1)		126
	3500 (1587)		11.4 (3.4)		171
	4500 (2041)		10.1 (3.0)		218
	5500 (2495)		7.9 (2.4)		291

WARNING SYMBOLS AND DEFINITIONS

	This is the safety alert symbol. It is used to alert you to potential personal injury hazards. Obey all safety messages that follow this symbol to avoid possible injury or death.
⚠ DANGER	Indicates a hazardous situation which, if not avoided, will result in death or serious injury.
⚠ WARNING	Indicates a hazardous situation which, if not avoided, could result in death or serious injury.
⚠ CAUTION	Indicates a hazardous situation which, if not avoided, could result in minor or moderate injury.
NOTICE CAUTION	Addresses practices not related to personal injury.

Symbol	Property or Statement
	Wear heavy-duty, cut- and abrasion-resistant leather gloves.
	Wear ANSI-approved safety glasses.
	Cut or sever hazard.
	Roller entanglement hazard.
	Hot surface burn hazard.
	Fire hazard.
	Caustic chemical (acid) hazard.
	Explosion hazard.
	Do not loop the synthetic rope around object and hook onto itself.
	Do not place finger(s) through hook. Fingers may be caught and get pulled into fairlead or drum.
	Pull hook using strap only.

Symbol	Property or Statement
	Do not use winch in overwind orientation. (Rope enters/exits at the top.)
	Use winch only in underwind orientation. (Rope enters/exits at the bottom.)
VDC	Volts Direct Current
A	Amperes
CCA	Cold Cranking Amperes
HP	Horsepower
fpm	Feet Per Minute
mpm	Meters Per Minute
RPM	Revolutions Per Minute
IP	International Protection rating Classifies the degrees of protection provided against the intrusion of solid objects, dust, accidental contact, and water.
G8	Grade 8 A fastener strength rating.

Important Safety Information



WARNING! Read all instructions.

Failure to follow all instructions may result in fire, serious injury and/or DEATH.

The warnings and precautions discussed in this manual cannot cover all possible conditions and situations that may occur. It must be understood by the operator that common sense and caution are factors which cannot be built into this product, but must be supplied by the operator.

Installation Precautions



1. Do not wear loose clothing or jewelry, as they can be caught in moving parts. Non-skid footwear is recommended. Wear restrictive hair covering to contain long hair.
2. Wear ANSI-approved safety goggles and heavy-duty leather work gloves during installation.
3. Before installation confirm that area is clear of fuel lines, brake lines, electrical wires, gas tanks or any other component which could be damaged during drilling.
4. Mounting location and hardware must support winch and load.
5. Use supplied power cords and synthetic rope listed in manual only. Do not use thinner/longer cables or link multiple cables together.
6. Do not route electrical cables near sharp edges or parts that will move or become hot.
7. Ventilate area well before and while working on battery. Explosive invisible hydrogen gas can accumulate and then explode when ignited by a spark from the battery connection.
8. Only connect to a clean, corrosion free battery.
9. Do not lean over or come in contact with battery while making connections.
10. Remove all metal jewelry before working near battery.
11. Connect red wire to positive battery terminal and black wire to negative battery terminal.
12. Insulate all exposed wiring and terminals after installation.
13. Install winch and fairlead in underwind orientation, so that the synthetic rope enters and exits the winch at the bottom of the drum.

Operation Precautions



1. Do not exceed load capacity. **Be aware of dynamic loading!** Sudden load movement may briefly create excess load causing product failure.
2. **Do not maintain power to the winch if the motor stalls.** Verify load is within rated capacity for the synthetic rope layer—see *Specifications* on page 2. Make sure the battery is fully charged. Use double line rigging whenever possible. Refer to *Double Line Rigging* on page 11.
3. Wear ANSI-approved safety goggles and heavy-duty leather work gloves during operation.
4. Do not disengage clutch under load. Engage clutch before starting.
5. Keep clear of fairlead when operating. Do not try to guide synthetic rope.
6. **Do not place finger(s) through hook or shackle.** Fingers may be caught and get pulled into fairlead or drum. Use included strap to hold hook instead.
7. Stay out of the direct line that the synthetic rope is pulling. If it slips or breaks, it will “whiplash” along this line. Place a heavy blanket or winch damper over the synthetic rope span 6 feet from hook to help absorb the force released if the synthetic rope breaks. Refer to Figure A.
8. Do not use for lifting or moving people.
9. Use a spotter to assist you in ensuring that it is safe to operate the winch. Make sure the spotter is out of the way of the vehicle and the synthetic rope before activating the winch.
10. Do not use the hand crank, if equipped, to “assist” the winch.
11. Do not use vehicle to pull on the synthetic rope and “assist” the winch.
12. Use as intended only. Do not lift items vertically or use for aircraft purposes.
13. Prevent entanglement. Do not wear loose clothing or jewelry, as they can be caught in moving parts. Non-skid footwear is recommended. Wear restrictive hair covering to contain long hair.
14. Disconnect battery cables before working near the synthetic rope, drum, fairlead or load, to prevent accidental starting.
15. Inspect before every use; do not use if damaged or parts loose. Examine the winch for structural cracks, bends, damage, frayed or damaged synthetic rope, and any other conditions that may affect the safe operation of the winch. Do not use the winch even if minor damage appears.
16. Keep children and bystanders away while operating. Distractions can cause you to lose control.
17. Stay alert, watch what you are doing and use common sense when operating. Do not use a winch while you are tired or under the influence of drugs, alcohol or medication. A moment of inattention while operating winches may result in serious personal injury.
18. Do not overreach. Keep proper footing and balance at all times. This enables better control of the winch in unexpected situations.
19. Hook onto the object using a pulling point, tow strap or chain. Do not wrap the synthetic rope around the object and hook onto the rope itself. This can cause damage to the object being pulled, and fray the synthetic rope.
20. **Do not use a Recovery Strap while winching.** They are designed to stretch and can suddenly whip back towards the operator during a winching operation.
21. Secure load after moving. **NO LOCKING MECHANISM.**
22. Keep at least 10 full turns of synthetic rope on drum. Synthetic rope requires more wraps than wire rope. The synthetic rope’s connection to the drum is not intended to sustain a load, without the added support from the friction of at least 10 full turns of rope.
23. Wrap synthetic rope under 500 lb. tension before use. Otherwise, synthetic rope may bind during operation.

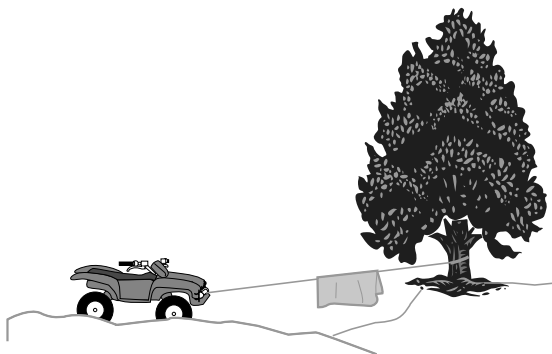

Figure A: Whiplash Dampening Blanket or Winch Damper

24. Keep clear of synthetic rope, hook, and load while winching. Do not step over synthetic rope.
Do not push sideways against synthetic rope under tension; synthetic rope might break under this load and recoil back, striking the person pushing against it or a bystander.
25. If synthetic rope begins to get entangled, stop winch immediately and release rope using switch.
26. Only winch with the winching vehicle's transmission in neutral. Winching with a vehicle's transmission in gear or park may damage the transmission. A vehicle's transmission is not designed to handle that type of load.
27. Do not operate the winch at extreme angles. Do not exceed the angles shown in Figure B for a roller fairlead. For a hawse fairlead, the angle should be as close to straight as possible.

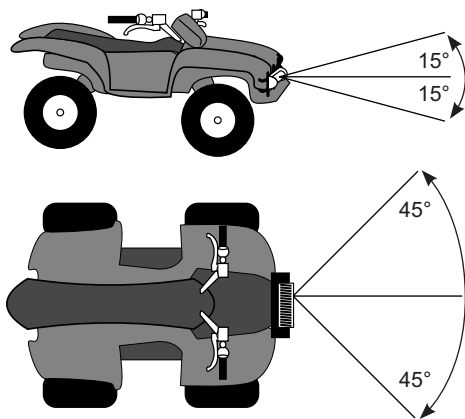

Figure B: Roller Fairlead Maximum Winching Angles

Service Precautions



1. Wear ANSI-approved safety goggles and heavy-duty leather work gloves during service.
2. Disconnect power to winch and allow it to cool completely before service.
3. Use supplied power cords/synthetic rope or cables listed in manual only. Do not use thinner/longer cables or link multiple cables together.
4. Have the winch serviced by a qualified repair person using only identical replacement parts. This will ensure that the safety of the winch is maintained.
5. Maintain labels and nameplates on the winch. These carry important safety information. If unreadable or missing, contact Harbor Freight Tools for a replacement.



SAVE THESE INSTRUCTIONS.

28. If the object to be pulled must be pulled at an angle in relation to the winch, use a snatch block (sold separately) and an anchor point directly in front of the winch, as shown in Figure C, to keep the synthetic rope pull straight.

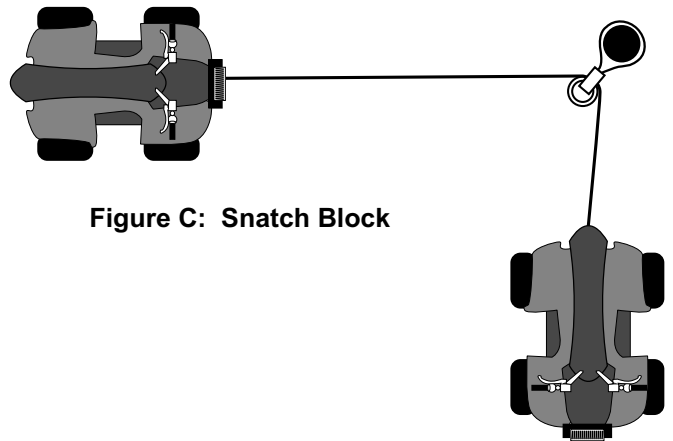

Figure C: Snatch Block

29. Wear work gloves to protect from cuts from debris when working with synthetic rope. Do not slide synthetic rope through hands, even with gloves on.
30. Winch motor will be hot during and after use. Keep clear.
31. Do not power the hook all the way into the fairlead or winch.
32. People with pacemakers should consult their physician(s) before use. Electromagnetic fields in close proximity to heart pacemaker could cause pacemaker interference or pacemaker failure.

Installation and Setup



Read the **ENTIRE IMPORTANT SAFETY INFORMATION** section at the beginning of this manual including all text under subheadings therein before set up or use of this product.

Mounting the Winch

1. The plate must be rated to at least the Winch's capacity.
2. Align the Winch perpendicular to center line of the vehicle at the desired location, and mark the locations of the Winch base holes. Compare the dimensions of the marked holes to Figure D.
3. Before drilling, verify that the installation surface has no hidden components or structural pieces that will be damaged.

Note: This Winch can generate extreme forces. Select a location that can withstand the rated capacity without damage or weakening. Steel reinforcement plates may be needed or a certified welder may need to weld on additional bracing depending on the mounting location.

4. Drill holes appropriate for the hardware at the marked locations.
5. Install the Winch using hardware described under *Specifications*.

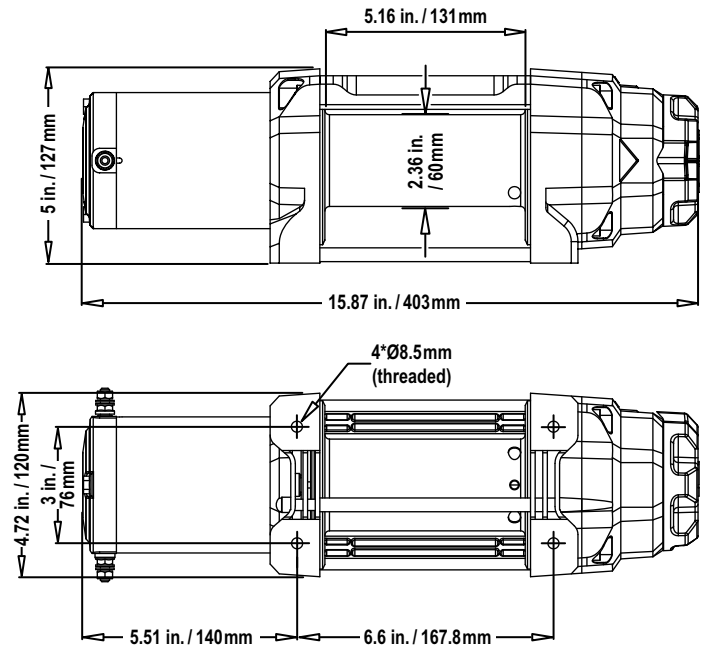

Figure D: Winch Dimensions

Mounting Winch Components

1. Mount Solenoid box, Disconnect Switch, and Socket Lead in proper locations so that:
 - a. Winch components are close enough to each other to allow wires to be routed properly.
 - b. Vehicle component operation is not interfered with.
 - c. Vehicle components are not damaged by drilling or driving screws.
 - d. Winch components will not be damaged by stresses caused by vehicle operation.
2. Mark the locations where the screw holes will be.
3. Verify that the installation surface has no hidden components or structural pieces that will be damaged before drilling.
4. Drill pilot holes for the mounting screws.
5. Secure in place with mounting screws.

Wiring

⚠ WARNING



TO PREVENT SERIOUS INJURY FROM EXPLOSION DUE TO SPARKING AT THE BATTERY CONNECTION:
Disconnect the Battery Cables before making other wiring connections.



TO PREVENT SERIOUS INJURY FROM LEAKING BATTERY ACID:
Do not use a dirty, corroded or leaking battery.
Only use a 12V automotive (or equivalent) battery, in good condition.

1. Plan a route for the wiring from the point of the vehicle where the Winch will be mounted, or used, to the battery. This route must be secure, out of the way of moving parts, road debris, or any possibility of being damaged by operation or maintenance of the vehicle. For example, you may wish to route the wires under the vehicle, attaching it to the frame using suitable fasteners. Do not attach the wires to the exhaust system, drive shaft, emergency brake cable, fuel line, or any other components which may create damage the wiring through heat or motion, or create a fire hazard.
2. If you drill through the bumper or any part of the body to route the wires, be sure to install a rubber grommet in the hole to prevent fraying of the wires at that point.
3. Route the Cables from the Solenoid to the battery and from the Solenoid to the Winch, following the precautions discussed earlier. Refer to Figure E.
7. Attach the black Battery Cable directly to the negative terminal of the battery.
8. Wire in the Remote Control, Dash Rocker Switch, and Socket Lead according to the diagrams on this page.
9. The cable leading from the Socket Lead has a red ignition wire extending out from its side. Connect this to an ignition circuit (switched by the vehicle's key) to help prevent accidental starting. **The Winch will not operate if that wire is not properly connected.**
 - a. Use a circuit tester to find a wire that energizes when the vehicle's key is turned to on, and turns off when the key is turned to off.
 - b. That is an ignition controlled wire. Connect the red Socket Lead ignition wire to that wire. Refer to Figure F.

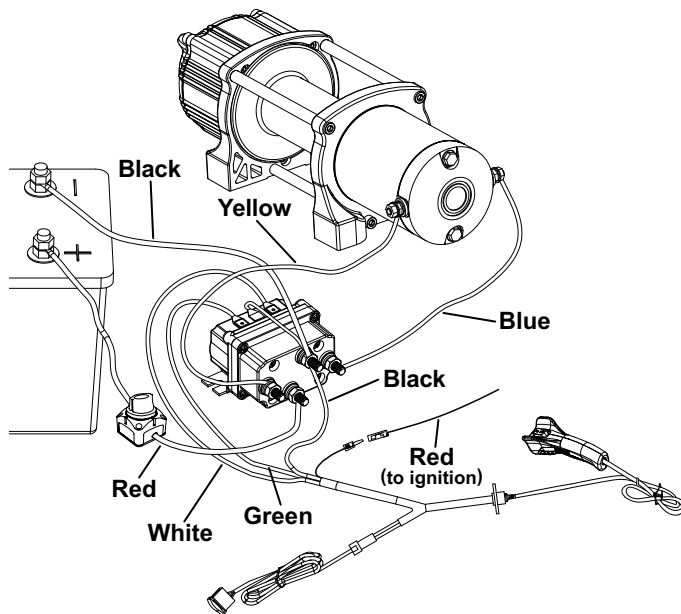

Figure E: Wiring Connections

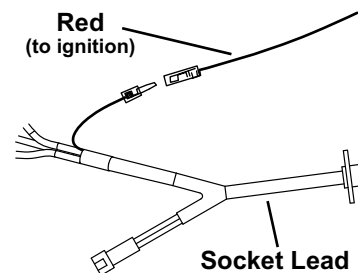

Figure F: Wiring to vehicle's keyed ignition

Note: If not attaching the Winch to a vehicle, attach the ignition wire to the positive battery terminal. **IF THIS IS NOT DONE, THE WINCH WILL NOT OPERATE.**

4. Attach the wires from the solenoid to the terminals on the Winch.
5. Attach the Disconnect Switch to the Positive Terminal on the battery.
6. Attach the red Battery Cable to the Disconnect Switch.
10. After the unit is mounted and powered, turn on the Disconnect Switch and operate the Power In and Power Out button on the Remote Control briefly to test Winch function and drum rotation direction. If operation is reversed, the Battery Cables may be connected backwards. Correct any such issue before use.
11. Disconnect and turn off the Remote Control when not in use.
12. Turn off the Disconnect Switch when the Winch is not in use or when the vehicle has returned to on-highway operation.

Disconnect Switch

WARNING! TO PREVENT SERIOUS INJURY: Off-highway driving subjects the vehicle and wiring to much higher vibrations than on-highway driving which can cause a breakdown of wiring insulation over time. Use the high current Disconnect Switch included with this Winch to turn OFF the power to the Winch when it is not in use to help reduce the risk of a short circuit.

1. To use the Winch, use the Disconnect Switch to turn the power to the Winch ON.
2. When the Winch is not in use, turn the Disconnect Switch OFF to reduce the risk of a short on the main power to the Winch.

Preparing the Synthetic Rope

The Synthetic Rope must be properly coiled under tension to be able to support a load without damage.

1. Find a suitable location where the Rope can be spooled onto the Winch while anchored to a solid object. Approximately 70 feet will be required. Alternately, a snatch block (sold separately) may be used to reduce the distance to 35 feet.
2. Turn the Clutch Knob counterclockwise to the Released (freespool) position. Turn the Knob completely until it stops. Uncoil the Synthetic Rope until 5 wraps remain on the drum. Turn the Clutch Knob clockwise back to the Engaged position.
3. Slowly and carefully move the vehicle in reverse to remove slack from the line.
4. Place the vehicle in neutral. Spool the Synthetic Rope back into the Winch while gently applying the brakes. If the ground is flat, shallow mud or dirt, the brakes can be fully applied. Pavement can generate much higher loads, in which case only light braking is needed.
5. Use a second person to monitor the rope spooling evenly onto the drum.
6. The last layer of Rope can be put on without tension.

The logo for BADLAND, featuring the word "BADLAND" in a bold, blocky, outlined font. The letters are white with a thick black outline. A registered trademark symbol (®) is located at the bottom right of the word.

Operation



Read the **ENTIRE IMPORTANT SAFETY INFORMATION** section at the beginning of this manual including all text under subheadings therein before set up or use of this product. The instructions that follow are basic guidelines only and cannot cover all situations encountered during use. The operator and assistants must carefully plan usage to prevent accidents.

Clutch Operation

CAUTION! Do not adjust the clutch unless there is no load on the Synthetic Rope.

1. To engage the clutch, turn the Clutch Knob clockwise completely until it stops. Refer to Figure G.
2. To release the clutch (freespool), turn the Clutch Knob counterclockwise completely until it stops. Refer to Figure G.

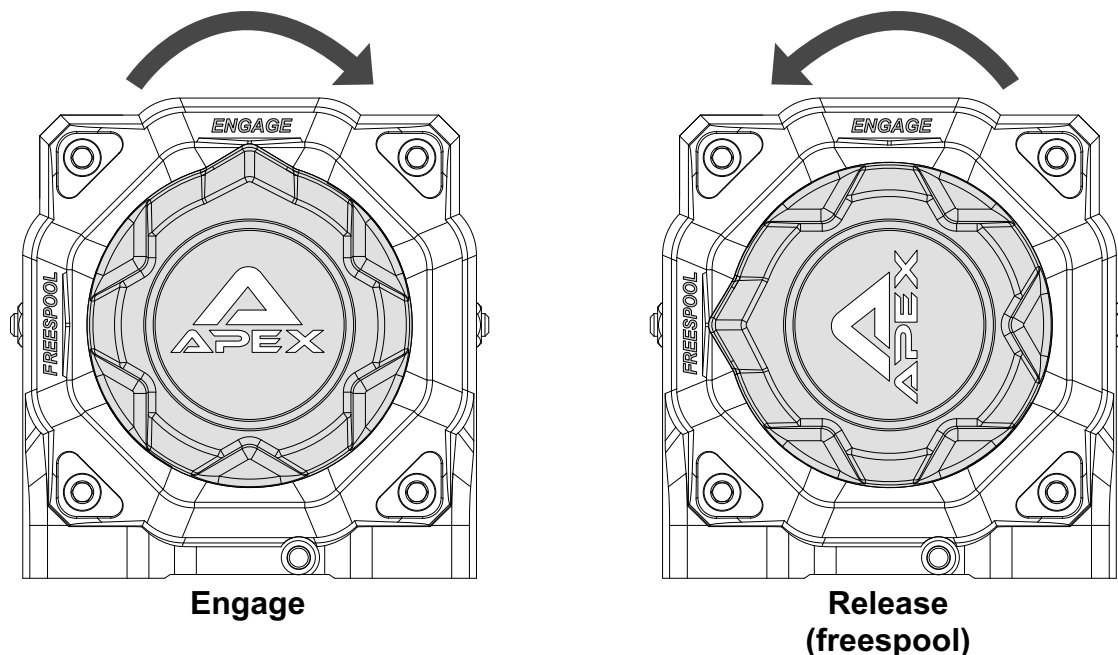

Figure G: Clutch Operation

Basic Operation

Note: If a winch is to be used to pull a vehicle, it should optimally be rated to a single line pull at least twice the vehicle's weight.

1. Examine the Synthetic Rope. Do not use the Winch if the Synthetic Rope is frayed or has cut strands.
2. Fully charge the vehicle's battery.
3. Check the Winch's electrical connections. All connections must be tight and clean.
4. Put the vehicle's transmission in Neutral.
5. If the vehicle where the Winch is mounted is not supposed to be moved, engage the emergency brake and block the wheels using wheel chocks (sold separately).
6. To pull out the Synthetic Rope, move the Clutch Knob to the Released position—see instructions for your Winch model under the *Clutch Operation* section. Slide the loop of the Hook Strap over the Hook, then pull on the Hook Strap to pull out the Synthetic Rope.
CAUTION! Leave at least ten full turns of Synthetic Rope on the drum.

- Hook onto the object using a pulling point, tow strap, tree strap, or chain. See Figure H. Shackle not shown between tree strap and hook.

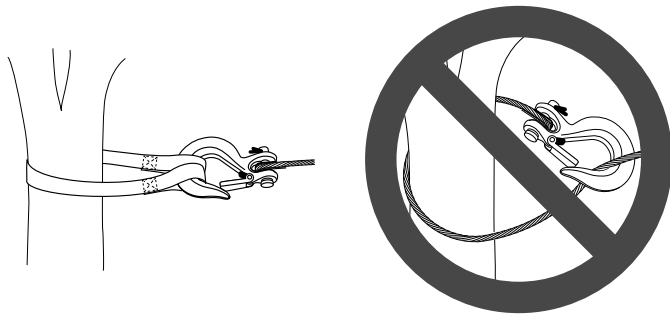

Figure H: Using a strap anchor point



Do not wrap the Synthetic Rope around the object and hook onto the Rope itself. This can damage the object being pulled and fray the Synthetic Rope.

- Attachment point must be centered in loop of hook and the hook's safety clasp must be fully closed. See Figure I.

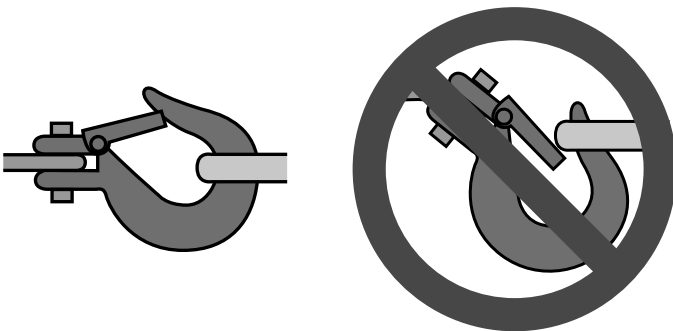

Figure I: Correct and incorrect hook attachment

- Do not use a Recovery Strap while winching.** They are designed to stretch and can suddenly whip back towards the operator during a winching operation.
- Place a heavy blanket or winch damper (sold separately) over the Synthetic Rope span 6 feet from the hook to help absorb the force released if the Synthetic Rope breaks.

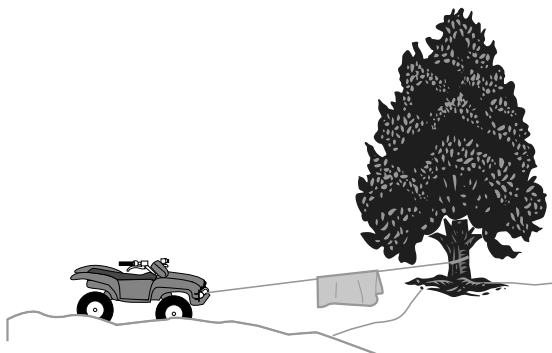

Figure A: Whiplash Dampening Blanket or Winch Damper

- Turn the Clutch Knob to the Engaged position. See the instructions for your Winch model under *Clutch Operation* on page 10.

WARNING! TO PREVENT SERIOUS INJURY: Do not allow anyone to stand near the Synthetic Rope, or in line with the Rope behind the Winch while it is under power. If the Synthetic Rope should slip or break, it can suddenly whip back towards the Winch, causing a hazard for anyone in the area. Stand well to the side while winching.

Double Line Rigging

- A double line system should be used whenever possible. It reduces the load on the winch, allowing it to work longer with less heat buildup. It reduces load on the winch in two ways:
 - It utilizes the lower layers of Synthetic Rope that have higher capacity, and
 - It halves the load on the winch through pulley action.
- Connect the Synthetic Rope for a double line system as shown in Figure J below. Use a snatch block (sold separately) properly rated for the load to be pulled and designed to be operated with this winch's Synthetic Rope.



Figure J: Double Line setup

- Loop the Synthetic Rope around the snatch block and connect to another part of the vehicle's chassis or to a separate anchor point. **Do not anchor the Rope back to the winch or winch mount.**

Note: If anchoring the winching vehicle, only attach the anchor line to the front of the vehicle. If the anchor line is attached to the rear of the vehicle, the vehicle's frame may be damaged by the forces exerted by winching.

- Operate the controls briefly to ensure they work properly.
 - The IN position should retract the winch cable.
 - The OUT position should power out the cable.

If operation is reversed, the power cables may be connected backwards. Correct any such issue before use.

- When it is safe to do so, use the power switch on the Remote Control to retract the Synthetic Rope, and winch the item as desired. **Do not power the Hook all the way into the Fairlead to prevent damage.**

14. Do not operate the Winch at extreme angles. Do not exceed the angles shown in Figure B for a roller fairlead. For a hawse fairlead, the angle should be as close to straight as possible.

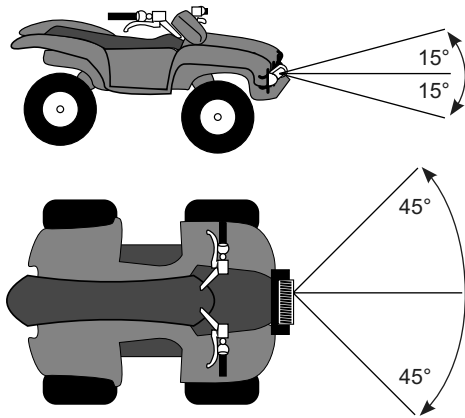

Figure B: Roller Fairlead Maximum Winching Angles

15. If the object to be pulled must be pulled at an angle in relation to the Winch, use a snatch block (sold separately) and an anchor point directly in front of the Winch, as shown in Figure C, to keep the Synthetic Rope pull straight.

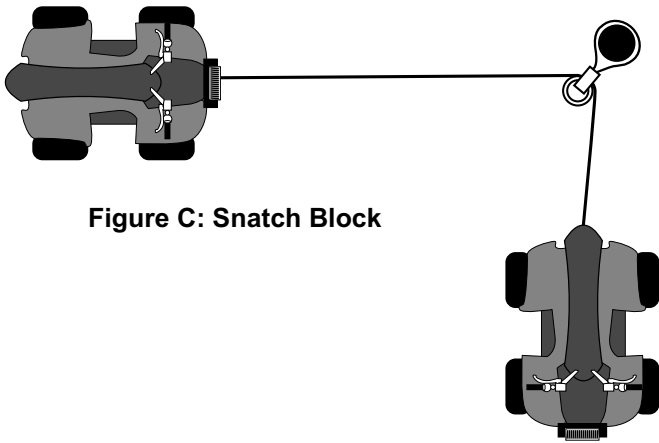

Figure C: Snatch Block

16. **WARNING! TO PREVENT SERIOUS INJURY:** Stop the Winch and release tension on the Synthetic Rope before moving the blanket or winch damper placed on it.
17. Do not continue use of the Winch until the battery is completely run down.
18. When possible, keep the engine running while using this Winch, to continually recharge the battery and prevent the battery from being drained so much that the vehicle cannot start. However, exercise extreme caution when working around a running vehicle and **ONLY** operate a vehicle in an outdoor area.

CAUTION! Do not use the Winch in a constant duty application, it is designed for **INTERMITTENT USE ONLY**. Keep the duration of the pulling job as short as possible. If the motor becomes very hot to the touch, stop and let it cool down for several minutes. Do not pull for more than one minute at or near the rated load. Do not maintain power to the Winch if the motor stalls. Double Line Rigging will help prevent overloading and should be used whenever practical. See *Double Line Rigging* on page 11.

19. When finished pulling the load, reverse the direction of the Winch just enough to release tension on the Synthetic Rope so that you can unfasten the Hook from the load and reel in the Rope.
20. Disconnect the Remote Control (if equipped) after use.

Duty Cycle (Duration of Use)

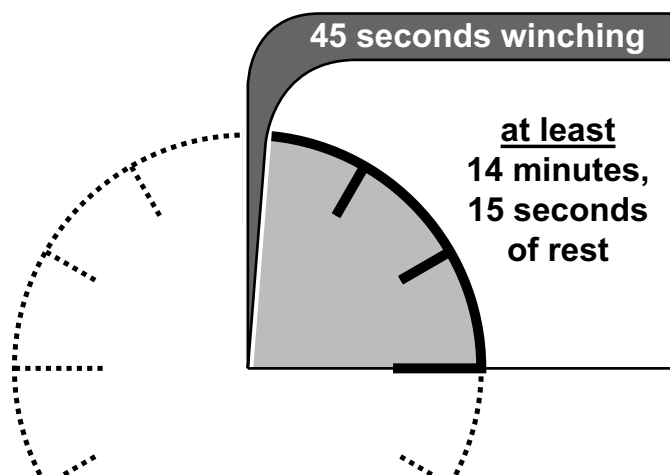

Avoid damage to the Winch by not winching for more than the prescribed duty cycle time. The Duty Cycle defines the amount of time, within a 15 minute period, during which a Winch can operate at its maximum capacity without overheating. For example, this Winch with a 5% duty cycle at its maximum load must be allowed to rest for at least 14 minutes, 15 seconds after every 45 seconds of continuous operation. Failure to carefully observe duty cycle limitations can easily over-stress a Winch contributing to premature Winch failure.

Maintenance and Servicing



Procedures not specifically explained in this manual must be performed only by a qualified technician.

WARNING



TO PREVENT SERIOUS INJURY FROM ACCIDENTAL OPERATION:

Disconnect the Battery Cables before performing any inspection, maintenance, or cleaning procedures.

TO PREVENT SERIOUS INJURY FROM WINCH FAILURE:

Do not use damaged equipment. If abnormal noise or vibration occurs, have the problem corrected before further use.

Cleaning, Maintenance, and Lubrication

- BEFORE EACH USE**, inspect the general condition of the Winch. Check for:
 - loose hardware
 - misalignment or binding of moving parts
 - cracked or broken parts
 - damaged electrical wiring
 - corroded or loose terminals
 - any other condition that may affect its safe operation.
- AFTER USE**, wipe external surfaces of the Winch with clean cloth.
- The Winch's internal mechanism is permanently lubricated. Do not open the housing. However, if the Winch is submerged, it should be opened, dried, and re-lubricated by a qualified technician as soon as possible to prevent corrosion.

Examine the Synthetic Rope. Do not use the Winch if the Rope is frayed or has cut strands.

Synthetic Rope Replacement

- Turn the Clutch Knob counterclockwise to the Released (freespool) position. Turn the Knob completely until it stops. Refer to *Clutch Operation* on page 10.
- Extend the Synthetic Rope to its full length, noting how the existing Rope is connected to the inside of the drum.
- Remove old Synthetic Rope and attach new assembly.
- CAUTION!** Do not replace with inferior synthetic rope. Only use a synthetic rope rated to the same rating cited on the specification chart or better.
- Retract Synthetic Rope onto Rope drum. Refer to instructions for tensioning the Synthetic Rope under *Disconnect Switch* on page 9.
- Test Winch for proper operation.

Troubleshooting

SAFETY

SETUP

OPERATION

MAINTENANCE

Problem	Possible Causes	Likely Solutions
Motor overheats.	<ol style="list-style-type: none"> 1. Incorrect power cords. 2. Winch running time too long. 3. Insufficient current or voltage. 4. Loose motor connections. 	<ol style="list-style-type: none"> 1. Use only supplied power cords. 2. Allow Winch to cool down periodically. 3. Fully charge battery. Run Winch with vehicle motor running. 4. Check and tighten motor connections to Solenoid.
Motor does not turn on.	<ol style="list-style-type: none"> 1. Remote Control not connected properly. 2. Loose battery cable connections. 3. Vehicle battery needs charging. 4. Solenoid malfunctioning. 5. Defective Remote Control. 6. Winch Disconnect Switch turned OFF. 7. Defective motor. 8. Water has entered motor. 9. Internal damage or wear. 	<ol style="list-style-type: none"> 1. Insert Remote Control cord all the way into connector. 2. Tighten nuts on all cable connections. 3. Fully charge battery. 4. Tap Solenoid to loosen contacts. Apply 12 volts to coil terminals directly. A clicking indicates proper activation. 5. Replace Remote Control. 6. Turn ON Winch Disconnect Switch. 7. Check for voltage at armature port with Switch pressed. If voltage is present, replace motor. 8. Allow to drain and dry. Run in short bursts without load until completely dry. 9. Have technician service Winch.
Motor runs but drum does not turn.	Clutch not engaged.	Turn the Clutch Knob to the Engaged position. If problem persists, a qualified technician needs to check and repair.
Motor runs slowly or without normal power.	<ol style="list-style-type: none"> 1. Insufficient current or voltage. 2. Loose or corroded battery cable connections. 3. Incorrect power cords. 	<ol style="list-style-type: none"> 1. Battery weak, recharge. Run Winch with vehicle motor running. 2. Clean, tighten, or replace. 3. Use only supplied power cords.
Motor runs in one direction only.	<ol style="list-style-type: none"> 1. Defective or stuck Solenoid. 2. Defective Remote Control. 	<ol style="list-style-type: none"> 1. Tap Solenoid to loosen contacts. Repair or replace Solenoid. 2. Replace Remote Control.
 <p>Follow all safety precautions whenever diagnosing or servicing the tool. Disconnect power supply before service.</p>		

PLEASE READ THE FOLLOWING CAREFULLY

THE MANUFACTURER AND/OR DISTRIBUTOR HAS PROVIDED THE PARTS LIST AND ASSEMBLY DIAGRAM IN THIS MANUAL AS A REFERENCE TOOL ONLY. NEITHER THE MANUFACTURER OR DISTRIBUTOR MAKES ANY REPRESENTATION OR WARRANTY OF ANY KIND TO THE BUYER THAT HE OR SHE IS QUALIFIED TO MAKE ANY REPAIRS TO THE PRODUCT, OR THAT HE OR SHE IS QUALIFIED TO REPLACE ANY PARTS OF THE PRODUCT. IN FACT, THE MANUFACTURER AND/OR DISTRIBUTOR EXPRESSLY STATES THAT ALL REPAIRS AND PARTS REPLACEMENTS SHOULD BE UNDERTAKEN BY CERTIFIED AND LICENSED TECHNICIANS, AND NOT BY THE BUYER. THE BUYER ASSUMES ALL RISK AND LIABILITY ARISING OUT OF HIS OR HER REPAIRS TO THE ORIGINAL PRODUCT OR REPLACEMENT PARTS THERETO, OR ARISING OUT OF HIS OR HER INSTALLATION OF REPLACEMENT PARTS THERETO.

Record Product's Serial Number Here: _____

Note: If product has no serial number, record month and year of purchase instead.

Note: Some parts are listed and shown for illustration purposes only, and are not available individually as replacement parts. Specify UPC 193175417060 when ordering parts.

Parts List and Assembly Diagram

Part	Description	Qty
1	Hex Socket Screw M6x18	4
2	Motor Assembly	1
3	Nut M8	4
4	Brake Base	1
5	Brake Spring	1
6	Brake Fork	1
7	Brake Fork Locating Ring	1
8	Brake Housing	1
9	Screw M4x8	3
10	Sliding Bearing	2
11	Seal	2
12	Aluminum Tie Bar (no logo)	1
13	Drum	1
14	Spring	1
15	Washer	1
16	Clip	3
17	Hex Plate	1
18	Spline	1
19	Copper Plate	1
20	Drive Shaft	1
21	Gear Box Base	1
22	Ring Gear	1
23	Plantary Gear 3	1
24	Spacer	2
25	Plantary Gear 2	1
26	Plantary Gear 1	1
27	Fork Pin	1
28	Screw M4x8	1
29	Clutch Knob Base	1
30	O-Ring	1
31	O-Ring	1

Part	Description	Qty
32	Gear Box	1
33	Hex Socket Screw M6x50	2
34	Clutch Knob	1
35	Badge	1
36	Hex Socket Screw M6x25	2
37	Pin 2.5x14	4
38	Tie Bar	1
39	Synthetic Rope	1
40	Aluminum Tie Bar (with logo)	1
41	Screw	2
42	Mounting Plate	1
43	Aluminum Hawse Fairlead	1
44	Flat Washer	2
45	Lock Washer	2
46	Nut	2
47	Hook	1
48	Hand Strap	1
49	Flat Washer	1
50	Lock Washer	4
51	Screw	4
52	Motor Lead – Red	1
53	Solenoid Lead – Blue	1
54	Solenoid Lead – Yellow	1
55	Battery Lead – Black	1
56	Disconnect Switch	1
57	Battery Lead – Red	1
58	Solenoid	1
59	Dash Mounted Rocker Switch	1
60	Remote Control	1
61	Socket Lead	1
62	Rubber Boot	6

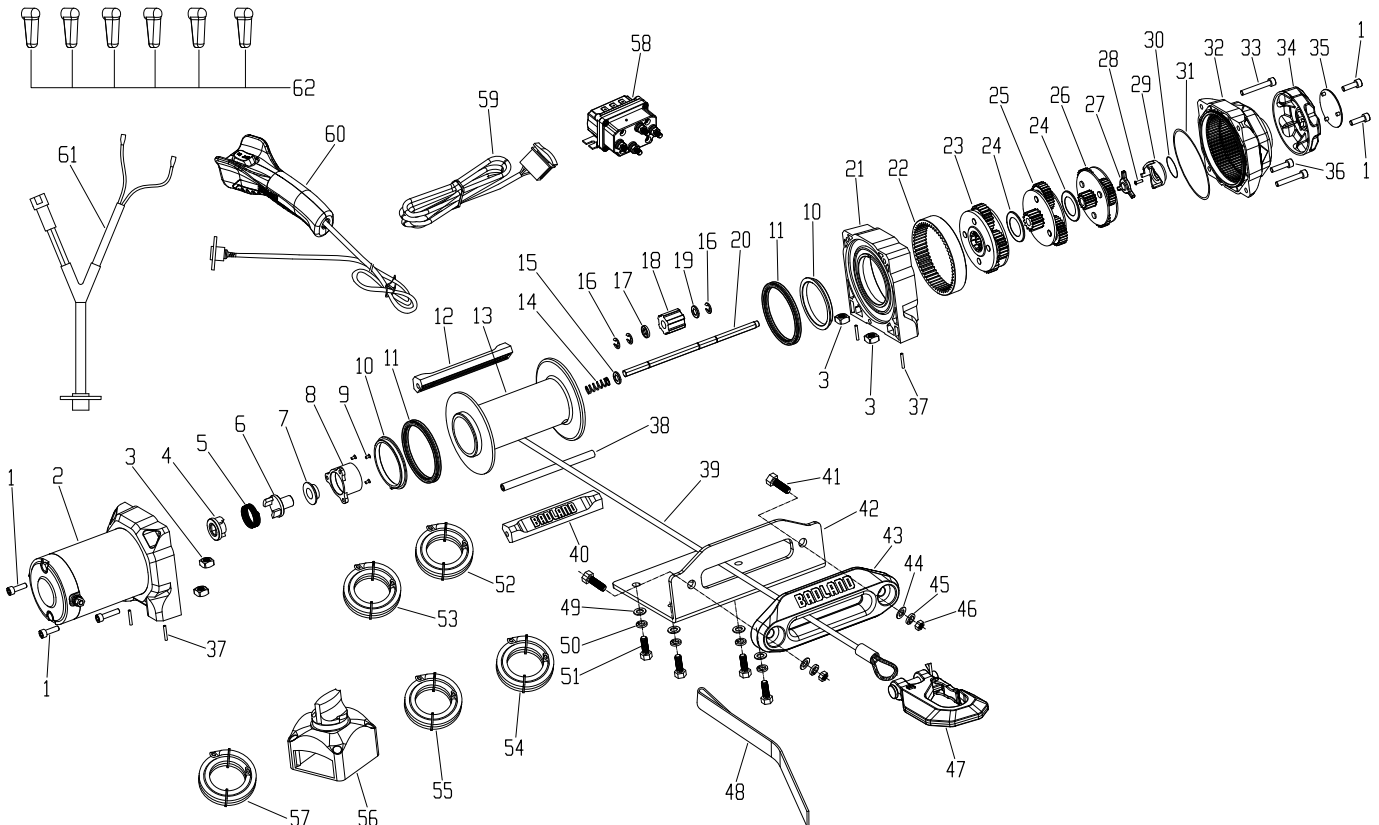

SAFETY

SETUP

OPERATION

MAINTENANCE

Limited 90 Day Warranty

Harbor Freight Tools Co. makes every effort to assure that its products meet high quality and durability standards, and warrants to the original purchaser that this product is free from defects in materials and workmanship for the period of 90 days from the date of purchase. This warranty does not apply to damage due directly or indirectly, to misuse, abuse, negligence or accidents, repairs or alterations outside our facilities, criminal activity, improper installation, normal wear and tear, or to lack of maintenance. We shall in no event be liable for death, injuries to persons or property, or for incidental, contingent, special or consequential damages arising from the use of our product. Some states do not allow the exclusion or limitation of incidental or consequential damages, so the above limitation of exclusion may not apply to you. THIS WARRANTY IS EXPRESSLY IN LIEU OF ALL OTHER WARRANTIES, EXPRESS OR IMPLIED, INCLUDING THE WARRANTIES OF MERCHANTABILITY AND FITNESS.

To take advantage of this warranty, the product or part must be returned to us with transportation charges prepaid. Proof of purchase date and an explanation of the complaint must accompany the merchandise. If our inspection verifies the defect, we will either repair or replace the product at our election or we may elect to refund the purchase price if we cannot readily and quickly provide you with a replacement. We will return repaired products at our expense, but if we determine there is no defect, or that the defect resulted from causes not within the scope of our warranty, then you must bear the cost of returning the product.

This warranty gives you specific legal rights and you may also have other rights which vary from state to state.

The logo for BADLAND is rendered in a bold, black, blocky font. Each letter is thick and has a slightly irregular, industrial feel. A small registered trademark symbol (®) is located at the bottom right corner of the letter 'D'.

26541 Agoura Road • Calabasas, CA 91302 • 1-888-866-5797

BADLAND®

GUIDE TO WINCHING



WWW.HARBORFREIGHT.COM

Copyright© 2019 by Harbor Freight Tools®. All rights reserved. No portion of this guide or any artwork contained herein may be reproduced in any shape or form without the express written consent of Harbor Freight Tools. Diagrams within this guide may not be drawn proportionally.

Table of Contents







Warning Symbols	3	Winch Basics	10
Important Safety Information	4	Single Line Winching—Straight Pull	14
Basic Winching Tips	7	Single Line Winching—Snatch Block	16
Before You Go	7	Double Line Winching.....	18
Estimating Load.....	8		













Read the **ENTIRE IMPORTANT SAFETY INFORMATION** section beginning on page 4 of this guide including all text under subheadings therein before use of this product. The instructions that follow are basic guidelines only and cannot cover all situations encountered during use. The operator and assistants must carefully plan usage to prevent accidents.

BADLAND®

WARNING SYMBOLS AND DEFINITIONS

	This is the safety alert symbol. It is used to alert you to potential personal injury hazards. Obey all safety messages that follow this symbol to avoid possible injury or death.
	Indicates a hazardous situation which, if not avoided, will result in death or serious injury.
	Indicates a hazardous situation which, if not avoided, could result in death or serious injury.
	Indicates a hazardous situation which, if not avoided, could result in minor or moderate injury.
	Addresses practices not related to personal injury.
	

Symbol	Property or Statement
	Wear heavy-duty, cut- and abrasion-resistant leather gloves.
	Wear ANSI-approved safety glasses.
	Cut or sever hazard.
	Roller entanglement hazard.
	Hot surface burn hazard.
	Fire hazard.
	Caustic chemical (acid) hazard.
	Explosion hazard.
	Do not loop the wire or synthetic rope around object and hook onto itself.
	Do not place finger(s) through hook. Fingers may be caught and get pulled into fairlead or drum.
	Pull hook using strap only.

Symbol	Property or Statement
	Do not use winch in overwind orientation. (Rope enters/exits at the top.)
	Use winch only in underwind orientation. (Rope enters/exits at the bottom.)
VDC	Volts Direct Current
A	Amperes
CCA	Cold Cranking Amperes
HP	Horsepower
fpm	Feet Per Minute
mpm	Meters Per Minute
RPM	Revolutions Per Minute
IP	International Protection rating Classifies the degrees of protection provided against the intrusion of solid objects, dust, accidental contact, and water.
G8	Grade 8 A fastener strength rating.

IMPORTANT SAFETY INFORMATION



WARNING! Read all instructions. Failure to follow all instructions listed on pages 4 to 6 may result in fire, serious injury and/or DEATH.

The warnings and precautions discussed in this manual cannot cover all possible conditions and situations that may occur. It must be understood by the operator that common sense and caution are factors which cannot be built into this product, but must be supplied by the operator.

Operation Precautions



1. Do not exceed load capacity. **Be aware of dynamic loading!** Sudden load movement may briefly create excess load causing product failure.
2. **Do not maintain power to the Winch if the motor stalls.** Verify load is within rated capacity for the wire or synthetic rope layer. Make sure the battery is fully charged. Use double line rigging whenever possible. Refer to *Double Line Winching* on page 18.
3. Wear ANSI-approved safety goggles and heavy-duty leather work gloves during operation.
4. Do not disengage clutch under load. Engage clutch before starting.
5. Keep clear of fairlead when operating. Do not try to guide rope.
6. **Do not place finger(s) through hook.** Fingers may be caught and get pulled into fairlead or drum. Use included strap to hold hook instead.
7. Stay out of the direct line that the rope is pulling. In case it slips or breaks, it will “whiplash” along this line.
8. Do not use for lifting or moving people.
9. Use a spotter to assist you in assuring that it is safe to operate the Winch. Make sure the spotter is out of the way of the vehicle and the rope before activating the Winch.
10. Do not use vehicle to pull on the rope and “assist” the Winch.
11. Place a heavy blanket or winch damper over the rope span 6 feet from hook to help absorb the force released if the rope breaks. Refer to Figure A.
12. Use as intended only. Do not lift items vertically or use for aircraft purposes.
13. Prevent entanglement. Do not wear loose clothing or jewelry, as they can be caught in moving parts. Non-skid footwear is recommended. Wear restrictive hair covering to contain long hair.
14. Disconnect remote control and turn off wireless function before working near the rope, drum, fairlead or load, to prevent accidental starting.
15. Inspect before every use; do not use if damaged or parts loose. Examine the Winch for structural cracks, bends, damage, frayed or kinked wire rope, frayed or cut synthetic rope, and any other conditions that may affect the safe operation of the Winch. Do not use the Winch even if minor damage appears.



Figure A: Whiplash Dampening Blanket or Winch Damper

16. A kink permanently weakens a wire rope, even after it is straightened out; kinked wire rope can fail suddenly and must not be used. Keep wire rope straight to avoid kinking the wire rope. The illustrations below show how a kink forms:

a. This illustration shows a kink about to form. At this point the winch should be stopped and the wire rope should be straightened out to prevent kinking.



b. This wire rope is kinked. It is too late to reverse the damage at this point, the wire rope must be discarded. It is permanently damaged and must not be used.



c. This is a kinked wire rope that has been straightened out. Even though it has been pulled straight, some wires in the wire rope are stretched, and others are severely bent, if not broken. The unstretched wires will take more load and can fail suddenly before the rope reaches its capacity. This wire rope must be discarded and not be used.

A kink permanently weakens the wire rope, even after it is straightened out; kinked wire rope can fail suddenly and must not be used.

- 17. Keep children and bystanders away while operating. Distractions can cause you to lose control.
- 18. Stay alert, watch what you are doing and use common sense when operating. Do not use a winch while you are tired or under the influence of drugs, alcohol or medication. A moment of inattention while operating winches may result in serious personal injury.

- 19. Do not overreach. Keep proper footing and balance at all times. This enables better control of the Winch in unexpected situations.
- 20. Hook onto the object using a pulling point, tow strap or chain. Do not wrap the rope around the object and hook onto the rope itself. This can cause damage to the object being pulled and kink or fray the rope.
- 21. **Do not use a Recovery Strap while winching.** They are designed to stretch and can suddenly whip back towards the operator during a winching operation.

22. Do not operate the Winch at extreme angles. Do not exceed the angles shown in Figure B for a roller fairlead and Figure C for a hawse fairlead.

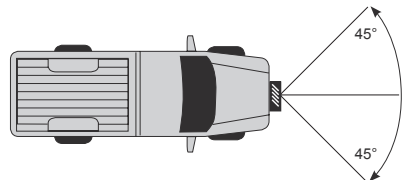

Figure B: Roller Fairlead Maximum Winching Angles

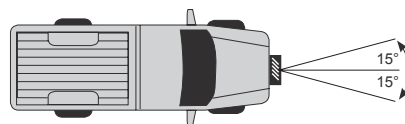

Figure C: Hawse Fairlead Maximum Winching Angles

23. If the object to be pulled must be pulled at an angle in relation to the Winch, use a snatch block (sold separately) and an anchor point directly in front of the Winch, as shown in Figure D, to keep the rope pull straight.

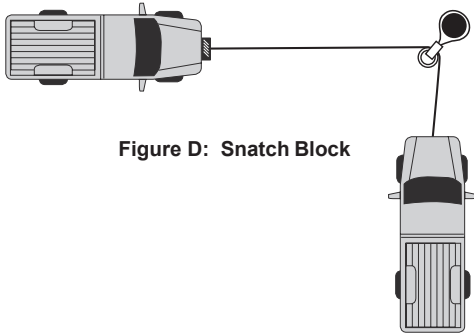

Figure D: Snatch Block

24. Wrap rope under tension before use. Otherwise, rope may bind during operation.

25. Keep clear of rope, hook, and load while winching. Do not step over rope.
Do not push sideways against rope under tension; rope might break under this load and recoil back, striking the person pushing against it or a bystander.

26. If rope begins to get entangled, stop Winch immediately and release rope using switch.

27. Only winch with the winching vehicle's transmission in neutral. Winching with a vehicle's transmission in gear or park may damage the transmission. A vehicle's transmission is not designed to handle that type of load.

28. Broken strands of a wire rope will be sharp. Wear heavy-duty work gloves when handling a wire rope. Do not slide a wire or synthetic rope through hands, even with gloves on.

29. Winch motor will be hot during and after use. Keep clear.

30. Do not power the hook all the way into the fairlead or Winch.

31. To prevent accidental starting, unplug winch controls and any RF receivers immediately after extending or retracting. This is especially important before rigging, installing, free spooling, or servicing.

32. People with pacemakers should consult their physician(s) before use. Electromagnetic fields in close proximity to heart pacemaker could cause pacemaker interference or pacemaker failure.

Service Precautions



1. Wear ANSI-approved safety goggles and heavy-duty leather work gloves during service.
2. Disconnect power to Winch and allow it to cool completely before service.
3. Use supplied power cords, rope or cables listed in manual only. Do not use thinner/longer cables or link multiple cables together.

4. Have the Winch serviced by a qualified repair person using only identical replacement parts. This will ensure that the safety of the Winch is maintained.
5. Maintain labels and nameplates on the Winch. These carry important safety information. If unreadable or missing, contact Harbor Freight Tools for a replacement.



SAVE THESE INSTRUCTIONS.

Basic Winching Tips

- **ESTABLISH A DANGER ZONE:**

At least 20ft on each side of the winch line and beyond the vehicle and anchor point. Make sure no people enter during the winching operation or when the line is under tension.



- **FIRST LAYER WINCHING:**

Winch with the most rope out possible to utilize the maximum power of the winch and prevent overloading and overheating.

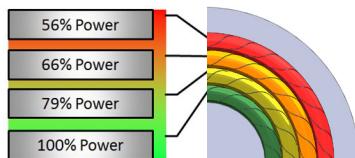

- **WINCH RECOVERIES ARE SLOW:**

Take time to properly evaluate the situation, and take all safety precautions. The loads that the winch can generate are extreme.

- **KEEP VEHICLE RUNNING:**

The winch will place an enormous amount of strain on the vehicle electrical system. Keeping the engine at 2000 RPM can provide some help from the alternator.

- **USE A SNATCH BLOCK:**

When in doubt of the recovery load or if the two vehicles are within 20ft of each other, use a snatch block for a double line pull.



- **KEEP THE VEHICLE IN NEUTRAL:**

The parking brake is not designed to hold the loads that the winch can apply. If recovering another vehicle, keep foot firmly on brake. For self-recovery, carefully steer vehicle to avoid obstacles and spotter and keep foot off brake.

- **KEEP THE LINE STRAIGHT:**

Winch with the rope as straight as possible to the winching vehicle. Use a snatch block if needed.

Before You Go

1. Check the power cables from the battery to the winch for abrasion and heat damage. Replace if worn or damaged.
2. The winch is an intermittently used product—over time the grease may settle in the gear train and make it difficult to freespool. Before a trip, check the winch for proper operation in three modes:
 - Power-IN
 - Power-OUT
 - Freespool
2. Inspect the rope for signs of abrasion damage, knots or kinks, or compression damage. Replace if damaged. See *Rope Inspection* on page 13 for more detail.
3. Ensure you have basic rigging hardware and safety gear such as: shackles, winch line damper, tree strap, safety glasses, and gloves. A snatch block is highly recommended.



Shackle



Damper



Tree Strap



Safety Gear



Snatch Block

Estimating Load

The ability to determine the load that the recovery will take is an important skill to learn. It allows you to properly setup rigging for a successful recovery the first time and reduces the chance of equipment damage and danger to bystanders.

Resistance Types

- **Grade Resistance:** The resistance of pulling a vehicle up a slope.
- **Mire Resistance:** The resistance of pulling a vehicle from soft terrain, such as mud, sand or snow.
- **Tackle Resistance:** The added resistance of snatch blocks during winching.

Grade Resistance

For recoveries or applications that pull a vehicle up a slope, grade resistance is a factor in the recovery load. This is because there are many other variables to consider off-road that add resistance. For example, the ground is not smooth or solid like pavement, the vehicle's wheels may not turn smoothly, the vehicle's steering may be broken, and a host of other factors.

For the majority of off-road recoveries, the grade resistance can be equal to the gross vehicle weight (GVW).

For smooth ramps used to load a trailer or other situations that are not as varied, you can use the following to estimate the recovery load. To estimate load you will need the gross vehicle weight (GVW) and the grade of the terrain.

- GVW can be found on the nameplate of the vehicle, or by a weigh station scale.
- % Grade = Rise / Run
Example: Rise 4ft / Run 10ft = 40% Grade

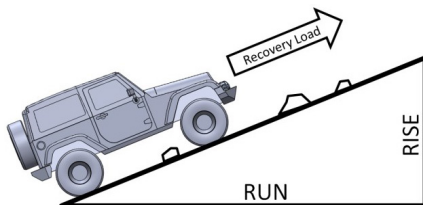

Reference the chart to find the estimated recovery load resistance.

Example: GVW of 6000lb on a 60% grade = recovery load of 51% of 6000lb = About 3060lb

Grade	Angle	% of GVW
20%	11	20%
40%	22	37%
60%	31	51%
80%	39	62%
100%	45	71%

Mire Resistance

For recoveries in mud, sand, or snow, mire resistance becomes a factor. Mire resistance is the added resistance that the soft terrain adds as the vehicle is submerged beneath the ground level. The vehicle's GVW is used to estimate the recovery load.

- Wheel Depth = 1x GVW

Wheel Depth Mire

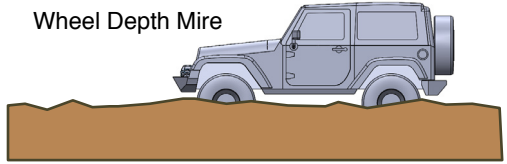

- Fender Depth = 2x GVW

Fender Depth Mire

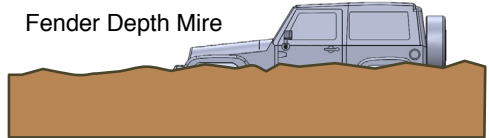

- Cab Depth = 3x GVW

Cab Depth Mire

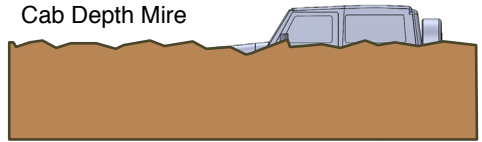

A snatch block is a great way to double the pulling power of your winch.

Tackle Resistance

Each shackle that is used in the recovery rigging adds a small amount of resistance to the winch. Each snatch block used in the recovery adds about 10% to the recovery load—add this to the recovery load on the winch.

Example: 4000lb recovery load +10% = 4400lb winch load

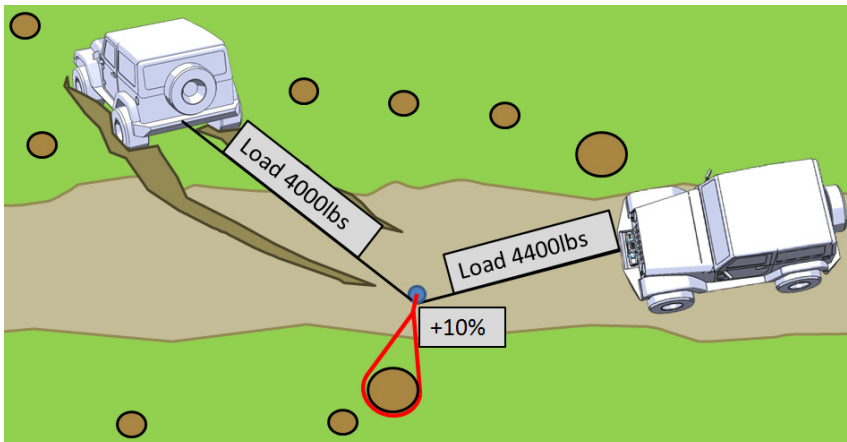

Winch Basics

Rope Layer

Imagine trying to hold a full length shovel horizontal by the very end of the handle—pretty hard, right?



Now imagine holding a shorter shovel by the end of the handle. Maybe not easy, but certainly easier than the full length shovel.

This is an example of how the winch must exert torque on the drum for the various layers of rope on the drum. The outermost layer of rope is represented by the full length shovel, and the first layer of rope is represented by the short shovel.

The winch and the vehicle electrical system have a limited amount of power available, so it is important to use the power in the most efficient way possible.

The winch can pull to 100% full rated load only on the first layer of rope that touches the drum.

For a constant load, as each layer of rope winds on, the winch must exert more torque on the drum, because of the added leverage of each layer.

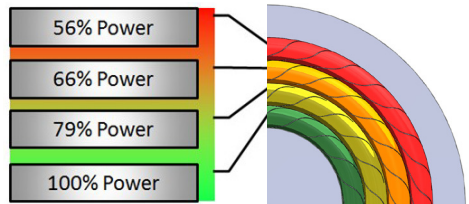

WARNING! To prevent serious injury from sudden detachment of the winch rope leave at least 5 full wraps of rope on the drum.

BADLAND®

Rope Angle

Your winch is designed to handle off-angle pulls for brief periods. However, extended pulls on one side of the drum can cause damage to the winch and rope. Use a snatch block to change the direction or move the anchor point.

Try to winch with the rope as straight into the winch as possible. If you do have to winch off-angle, do not exceed the angles shown below.

Spotter must be outside danger zone. Have spotter watch for even winding of rope on drum. If rope starts winding unevenly on the drum, stop winching and adjust rigging or vehicle position. Freespool the winch to remove the rope bunching on the drum flange and evenly spool the rope back on the drum, then continue the recovery.

Or, plan ahead and use a snatch block to ensure that an off-angle pull will be avoided. Periodically check your fairlead for wear and replace as needed.

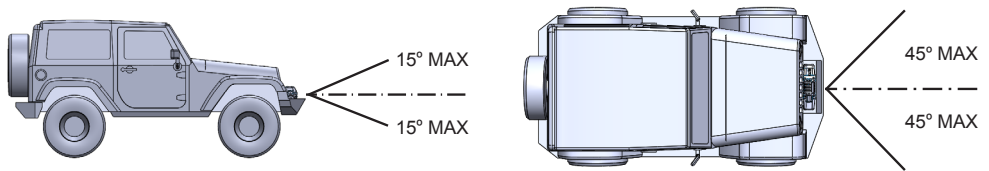

Roller Fairlead Maximum Winching Angles

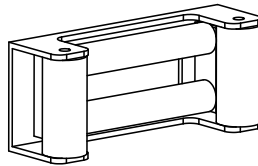

Roller Fairlead

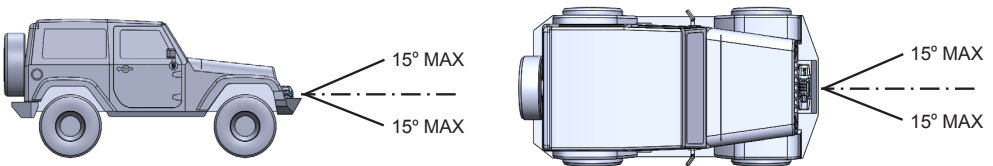

Hawse Fairlead Maximum Winching Angles

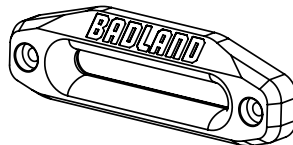

Hawse Fairlead

Snatch Blocks

Snatch blocks are the second most important accessory for your winch (the first being shackles). Being able to change the line direction for pulls around corners and multiple line pulls makes them extremely versatile. Let's understand how they work before we show examples of vehicle recoveries.

The most basic use of a snatch block is to change the direction of a rope. In the diagram a 4 ton vehicle is attached to a rope which passes around a snatch block to a winching vehicle.

Notice that the tension in each of the ropes is equal to the total load weight, and the snatch block must carry the combined load of the ropes.

This is a simplified example neglecting the angle of pull of the ropes. As the angle between the ropes increases, the load on the snatch block will decrease.

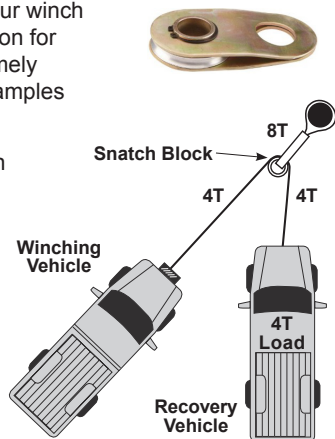

Example 1: Direction Change

In a direction change situation, the objective is to pull from a direction that has a greater impact on the stuck vehicle. In this example the weight is the stuck vehicle and the snatch block is attached to an anchor point. The snatch block does not provide any increase to the recovery force but it does change the direction of the pull.

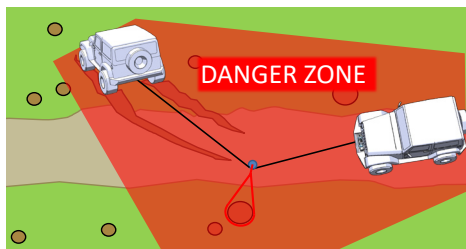

Example 2: Recovery Force Increase

In a situation where the recovery will take more force than the winch can provide, a double line pull should be used. This can help reduce the load on the winch and decrease the electrical load on the vehicle.

In this example the weight becomes the vehicle with the winch, and the snatch block is again connected to an anchor point. The usefulness of this rigging is to leverage the doubled force of the two ropes that the snatch block carries, allowing the recovery force to be double that of a single line pull.

Additionally the double line rigging will require more rope off the drum, allowing the winch to work on lower layers and provide more available pull force.

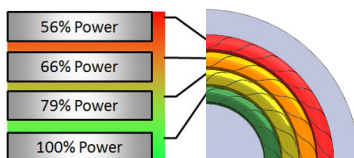
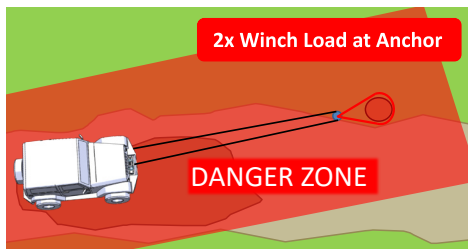

Rope Inspection

The rope on the winch is the highest wear item in the winching system, and the most dangerous if not inspected regularly. Wire rope and synthetic rope have different wear and replacement criteria—it is important to highlight both.

Wire Rope—Always Replace

WARNING! To prevent serious injury from razor sharp broken strands, wear heavy-duty work gloves when handling wire rope. Do not run hands along wire rope, even with gloved hands—some wire strands can be sharp enough to pierce gloves.

- Kinked Strands: Replace



- Separated Strand: Replace



- Broken Strands: Replace



- Twisted Rope: Replace



Synthetic Rope

CAUTION! Wear work gloves to protect from cuts from debris when working with synthetic rope.

- Abrasion: Severe abrasion must be replaced; minor abrasion or a fuzzy look can be monitored.



- Cut Strands: Replace immediately.



- Pulled Strand: Repair—work the strand carefully back into the rope.



- Compression: Commonly seen on drums. Repair—flex the rope without load to remove the compression.



Single Line Winching—Straight Pull

Setup

WARNING! To prevent serious injury from electrical fire: check the electrical cables to your winch for abrasion or heat damage before use. Replace worn or damaged cables immediately.

1. MAKE A PLAN. Pick a sturdy anchor such as a large tree, large rock, or other vehicle that is generally straight on and that allows for sufficient rope out to obtain maximum power from the winch.
2. PUT ON GLOVES. Regardless of synthetic or wire rope, heavy-duty work gloves are always a good idea.
3. Place the winch into freespool.

Rigging

1. Pull the hook out using the strap to the anchor point. Don't forget any rigging you will need, such as a tree strap and shackle.

WARNING! To prevent serious injury from sudden detachment of the winch rope leave at least 5 full wraps of rope on the drum.

2. Secure the winch rope to the anchor point. Do not wrap the winch rope directly around a tree or rock. Not only will this damage or kill the tree, but it will also damage the rope where the hook attaches back to the rope.

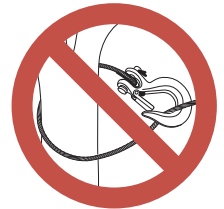
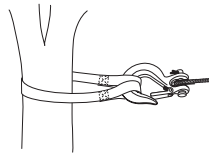

3. If possible, have the latch side of the hook facing up. This will help force the hook to the ground if the hook should fail or slip off the rigging.

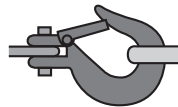

4. Make sure the hook is fully engaged on the shackle or vehicle anchor point. THE HOOK LATCH MUST CLOSE.
5. Place a winch damper or other heavy object on the line, 1/3 of the total distance from the hook end of the rope.

Use double line rigging whenever practical to prevent overloading and overheating of the winch.

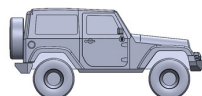

Damper

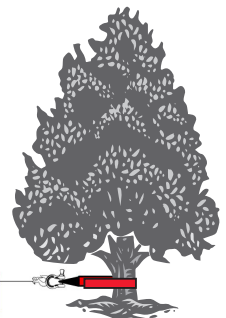

- ESTABLISH A DANGER ZONE. At least 20ft on each side of the winch line and beyond the vehicle and anchor point. Make sure no people enter during the winching operation or when the line is under tension.



WARNING! Do not allow anyone to stand near the rope, or inline with the rope behind the winch or anchor point while it is under power. If the rope should slip or break, it can suddenly whip back towards the winch or anchor, causing a hazard for anyone in the area established by the danger zone. Stand well to the side when winching.

Winching

For self recovery:
Place winch vehicle in NEUTRAL • Keep foot OFF brake

For other vehicle recovery:
Place winch vehicle in NEUTRAL • Keep foot ON brake

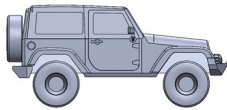

Damper



- Re-engage the freespool clutch, and plug-in or connect the remote to the winch.
- Slowly take up slack in the winch line to do a final check on the rigging setup. Designate one person as a spotter to watch for vehicle hazards and to make sure the rope is spooling on the drum correctly.
- Perform the winching operation, with the vehicle in NEUTRAL or DRIVE. Watch your spotter, and monitor the battery voltage while winching. Increase the engine RPM to raise the battery voltage level.
- When the vehicle is recovered engage parking brakes, remove all rigging and wind the rope fully into the winch USING THE HOOK STRAP.
- Unplug or disconnect the remote and store it in the vehicle for the next use.

NOTICE: Your winch is designed for INTERMITTENT USE ONLY. If the motor stalls, STOP OPERATION and use a snatch block.

Duty Cycle (Duration of Use)

Avoid damage to the Winch by not winching for more than the prescribed duty cycle time. The Duty Cycle defines the amount of time, within a 15 minute period, during which a Winch can operate at its maximum capacity without overheating. For example, a Winch with a 5% duty cycle at its maximum load must be allowed to rest for at least 14 minutes, 15 seconds after every 45 seconds of continuous operation. Failure to carefully observe duty cycle limitations can easily over-stress a Winch contributing to premature Winch failure.

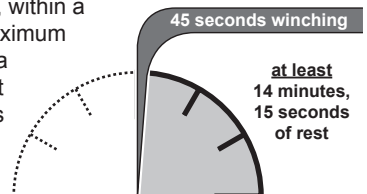

Single Line Winching—Snatch Block

Overview

Not every recovery can be handled with a straight line pull. Often the most effective recovery requires an angle that cannot be accomplished from straight on. By using a snatch block on a single line pull, the pull direction can be changed without moving the winching vehicle.

Around a Corner

When stuck on a hill or tight trail and an anchor point is too close to winch effectively, a snatch block can be used. Not only does this lower the rope layer so that the winch can pull harder, it also allows the vehicle to remain connected to the farthest anchor once the snatch block is removed.

Pay special attention to the danger zone, since it is much larger than a straight line pull.

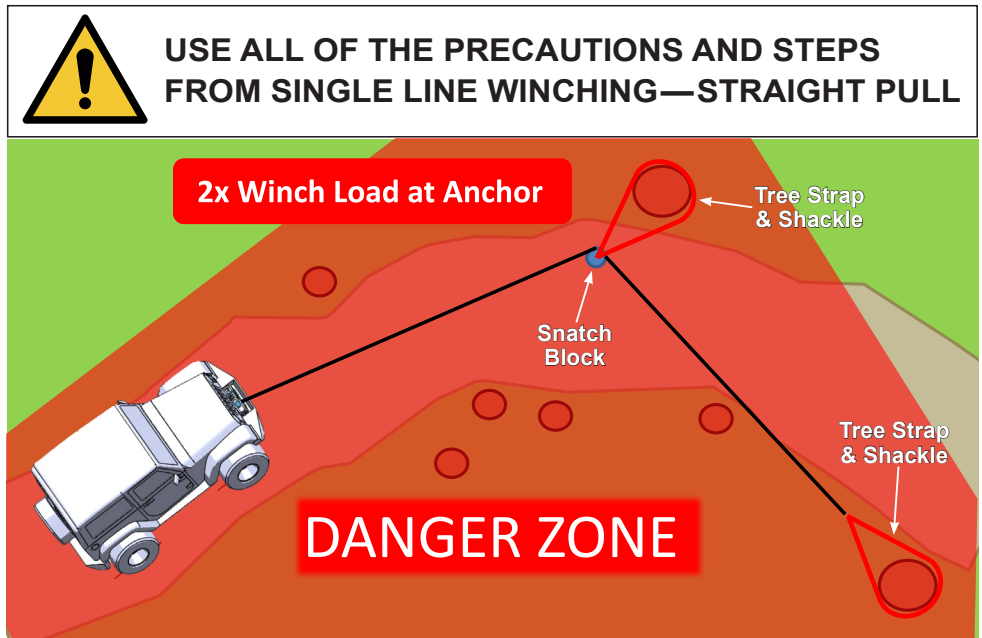

Rigging Needed:

- 2x Tree Straps
- 2x Shackles
- 1x Snatch Block

Vehicle Off Trail

If a vehicle leaves the trail and becomes stuck, often the most effective way to return the vehicle to the road is using an angled pull since this pulls the vehicle most directly onto the trail. Find a suitable anchor on the opposite side of the trail to attach a snatch block to, and perform the recovery.

Pay special attention to the danger zone, since it is much larger than a straight line pull.

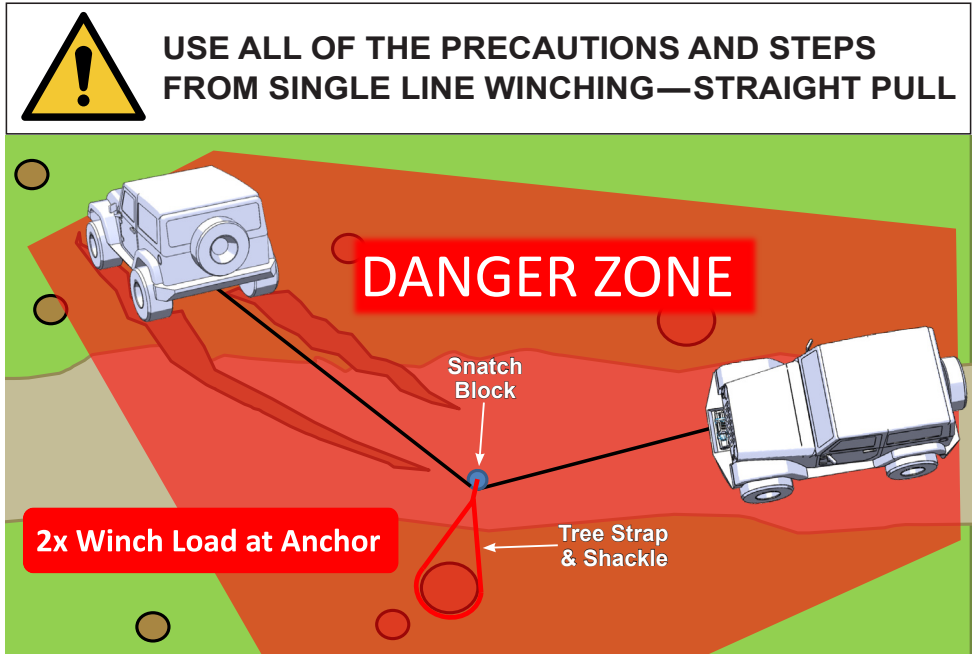

Rigging Needed:

- 1x Tree Strap
- 2x Shackles – Possibly more depending on tow points of stuck vehicle
- 1x Snatch Block

For self recovery:

Place winch vehicle in NEUTRAL • Keep foot OFF brake

For other vehicle recovery:

Place winch vehicle in NEUTRAL • Keep foot ON brake

Double Line Winching

Overview

Certain recoveries require more force than a single line pull can provide. In these situations a double line pull is necessary to develop enough force to recover the vehicle.

Double Line—Self Recovery

For self recovery efforts that require more force than a single line pull can provide, use a double line rigging back to the winching vehicle. Make sure the rigging at the anchor is rated to withstand the estimated load to recover the vehicle.

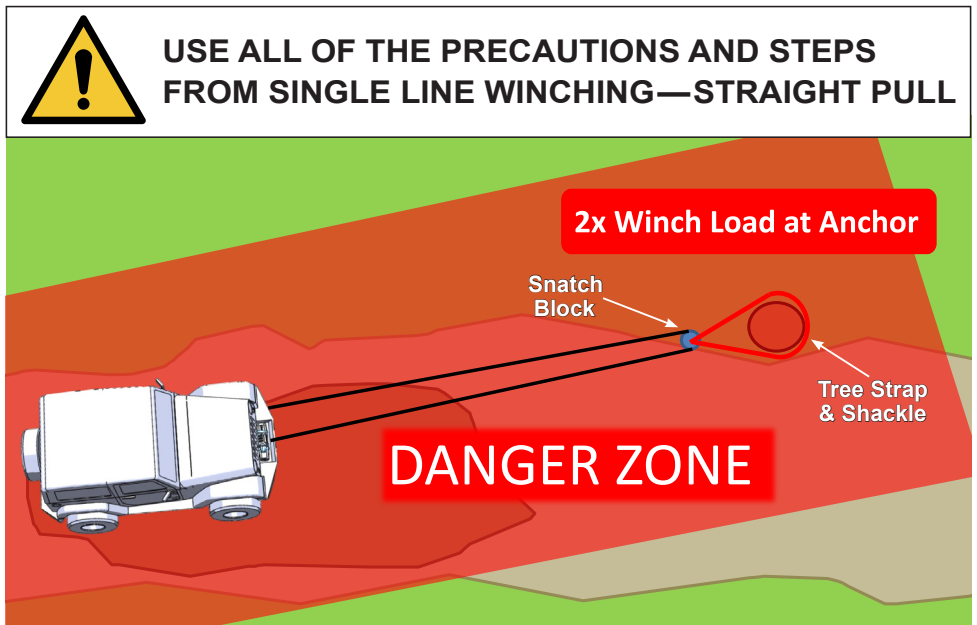

Rigging Needed:

- 1x Tree Strap
- 2x Shackles – Possibly more depending on tow points of stuck vehicle
- 1x Snatch Block

For self recovery:

Place winch vehicle in NEUTRAL • Keep foot OFF brake

Double Line—Other Vehicle Recovery

By placing the hook end at a stationary anchor or other vehicle and attaching a snatch block to the recovery vehicle, the load on the winching vehicle is reduced by 50%. This can be especially helpful in low traction conditions such as snow or mud.

Pay special attention to the danger zone, since it is much larger than a straight line pull.

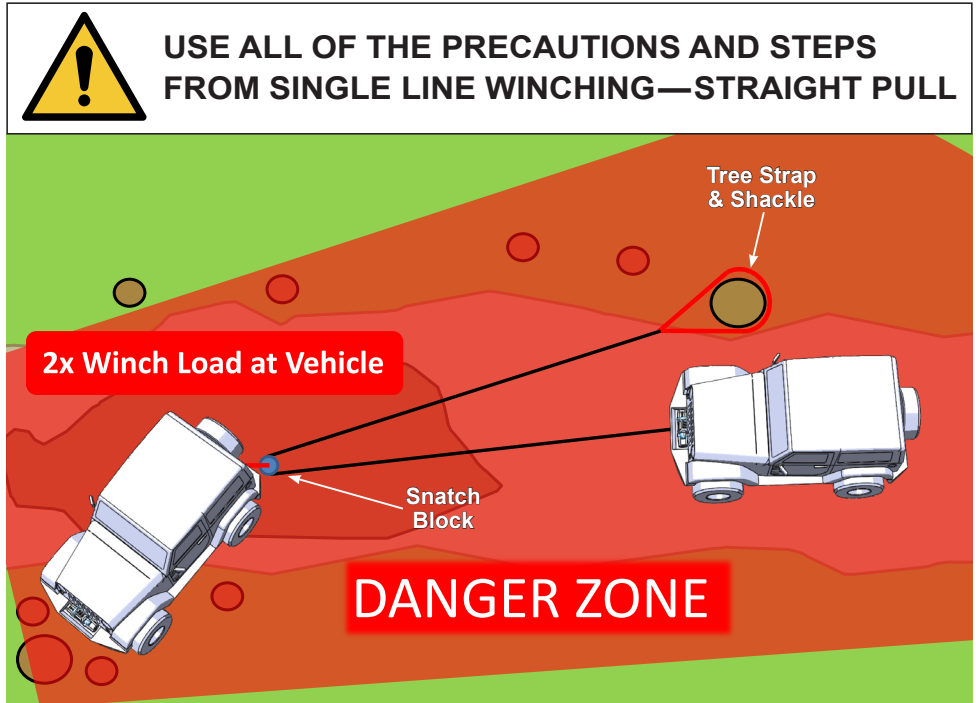

Rigging Needed:

- 1x Tree Strap
- 2x Shackles – Possibly more depending on tow points of stuck vehicle
- 1x Snatch Block

For other vehicle recovery:

Place winch vehicle in NEUTRAL • Keep foot ON brake

BADLAND®

26541 Agoura Road • Calabasas, CA 91302 • 1-888-866-5797